

NOTES:

- MATERIAL:
 - HOUSING: THERMOPLASTIC, HIGH TEMP.,UL94V-0. COLOR:BLACK.
 - ACTUATOR: THERMOPLASTIC, HIGH TEMP.,UL94V-0. COLOR:NATURAL.
 - CONTACT: COPPER ALLOY.
 - FITTING NAIL: COPPER ALLOY.
- FINISH:
 - TERMINAL CONTACT:
 - 50~100u" NICKEL UNDERPLATING OVERALL.
 - 1: GOLD FLASH ON CONTACT AREA AND SOLDER AREA.
 - FITTING NAIL:
 - 50~100u" NICKEL UNDERPLATING OVERALL.
 - GOLD FLASH
- REFLOW SOLDER CAPABLE TO 260°C PER ACES SPEC.
- SPEC.PLS REFER TO PS-50507-XXXXX-XXX
- PACKAGE PLS REFER TO 51579-XXXXX-XX-TRP
- PART NUMBER

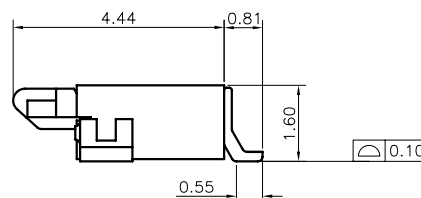
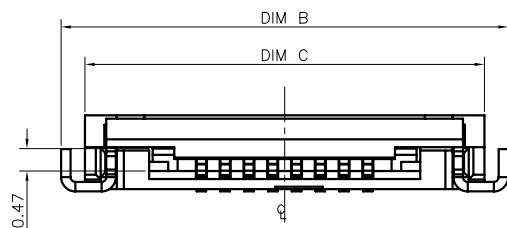
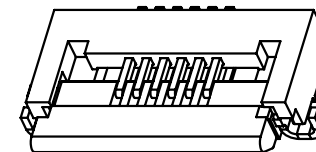
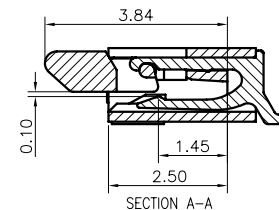
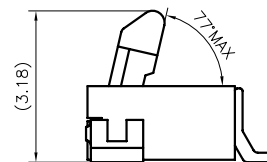
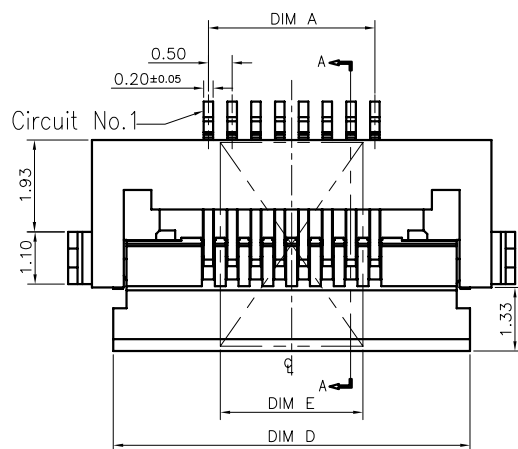
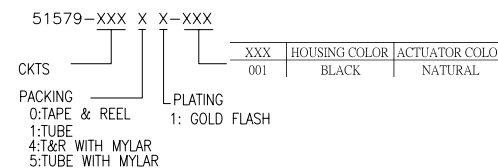

XXX	DIM A	DIM B	DIM C	DIM D	DIM E
004	1.50	7.40	6.40	5.50	3.00
008	3.50	9.40	8.40	7.50	3.00
012	5.50	11.40	10.40	9.50	3.00
016	7.50	13.40	12.40	11.50	3.00
018	8.50	14.40	13.40	12.50	6.00
023	11.00	16.90	15.90	15.00	10.00

一般公差 TOLERANCES X ±0.5 .XX ±0.15 X ±0.25 .XXX ±0.1 ANGLES ±2°		宏致電子股份有限公司 Aces Electronics Co.,Ltd.	
檢驗尺寸標示 SYMBOLS ⊕ ⊗ INDICATE CLASSIFICATION DIMENSION ⊕ MARK IS CRITICAL DIM. ⊗ MARK IS MAJOR DIM.	品名 (TITLE) 0.5 mm PTICH ZIF FPC S/T R/A H=1.5 mm	製圖 (DR) 15/04/29 XUBIN	審核 (CHKD) BRAVE
	圖號 (DWG NO.)	核准 (APPD)	
表面處理 (FINISH)	比例 (SCALE)	單位 (UNITS)	張數 (SHEET)
	8:1	mm	1 OF 1
		尺寸 (SIZE)	REV
		A4	B